

FORD

TRUCK CAPS

 **LEER**[®]



FOR ALL THINGS TRUCK-RELATED, TRUST THE ORIGINAL TRUCK EXPERTS.

For over 60 years, LEER® has never rested. We constantly push every process, every component, latch, and knob to exceed expectations, last longer, and be stronger. We fully believe beauty, brawn, and brains are never optional but mandatory. Protecting your valuable cargo is paramount. This is our commitment to you: a relentless passion for unsurpassed quality that makes LEER not only a leader, but a legend.



**NORTH AMERICA'S
MOST TRUSTED
TRUCK CAPS**

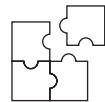

**CUSTOM CREATED
TO MATCH EVERY
TRUCK MODEL**



**AERODYNAMIC
STYLING FOR
IMPROVED AIRFLOW**



**LIMITED LIFETIME
WARRANTY†**

† See complete warranty statement for details.





E

R

E

BEAUTY. BRAWN. BRAINS.

LEER® fiberglass truck caps are the perfect blend of capability, capacity, and convenience designed to make life easier, more successful, and more fun. With multiple models to choose from — all loaded with standard features and customizable options — LEER offers incredible flexibility to get exactly what you want, including upgraded security, window functionality, and the latest innovations like keyless entry.

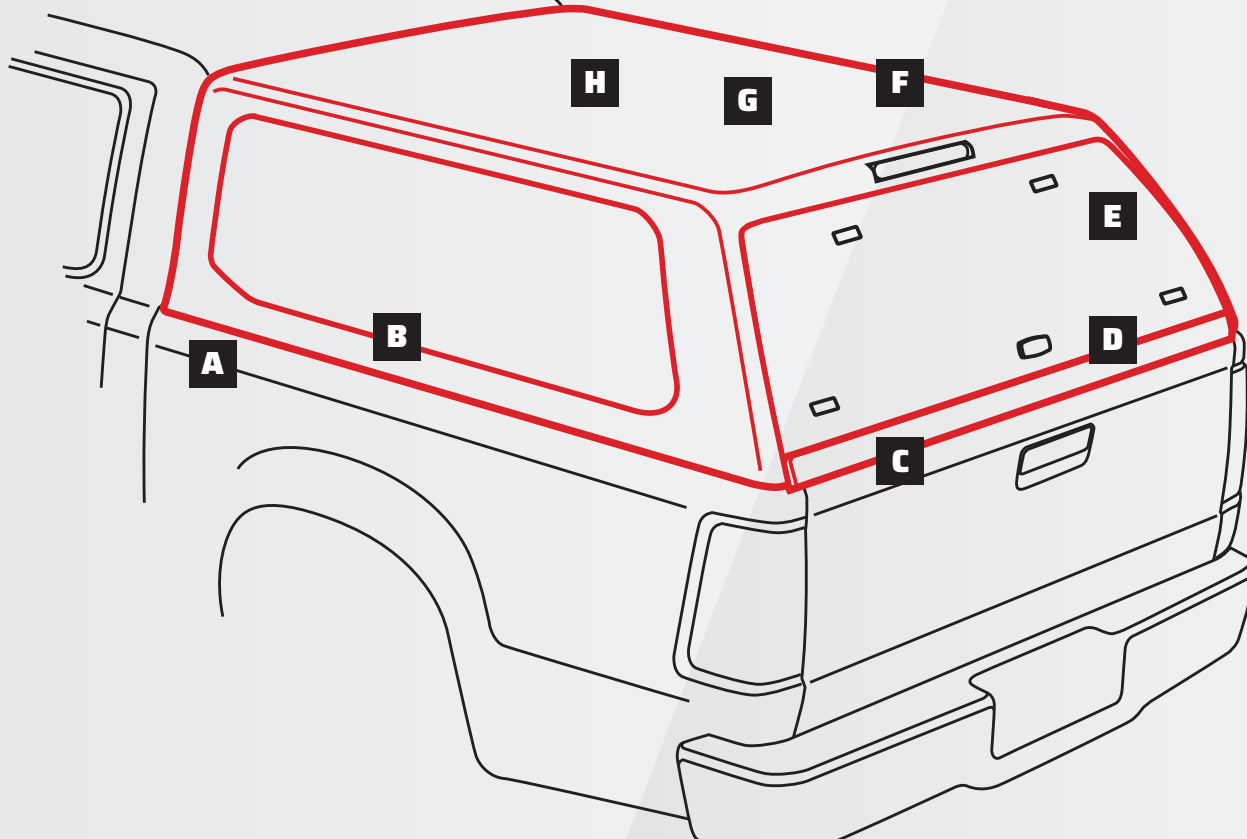

- A** Custom Designed for Every Ford Truck Model
- B** Precision Engineered to Fit Your Truck Bed
- C** Contoured Tailgate Overlay
- D** Heavy-duty, Weather-resistant Seals
- E** Tinted, Tempered Automotive Glass Rear Doors and Side Windows
- F** Axalta Automotive Paint for Color Match
- G** Low Resin-filled Fiberglass for Improved Impact Resistance
- H** Reinforced Roof

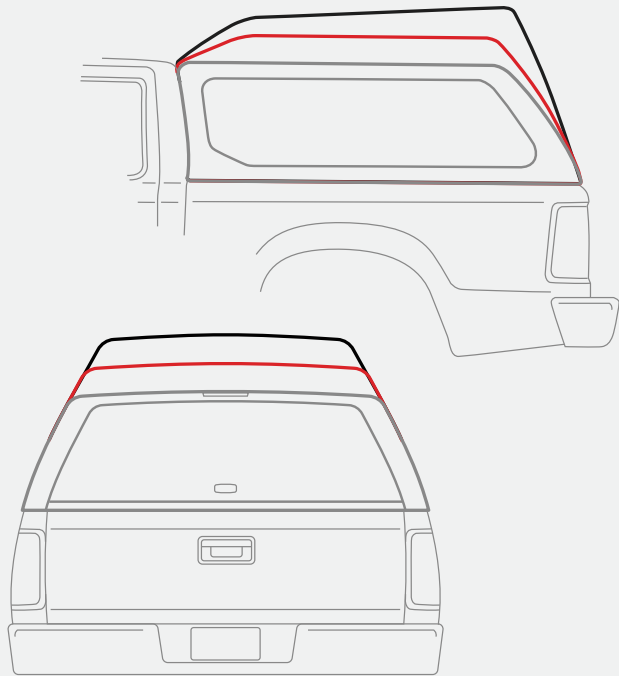

LEER CAP HEIGHTS

Capacity should never hold you back. LEER offers three cap heights so you never fall short on any challenge. And with our balanced design approach of cargo capacity, fuel-efficiency, low road noise, and stunning aesthetics, LEER truck caps always deliver on both form and function.

HIGH-RISE up to 40% more storage capacity on LEER 122

MID-RISE up to 15% more storage capacity on LEER 180 Series

CAB-HIGH Consistent height with your truck cab

WINDOWS TO THE WORLD

Windows matter. But not one window is right for everyone, so LEER® gives you many options for both cab and side windows to get the look, ventilation, and utility you're after. From solid windows to tip-outs, sliding to removable, it's your truck cap, and we aim to make it not just meet but exceed your expectations. When choosing your window, see the features & options chart on page 11.

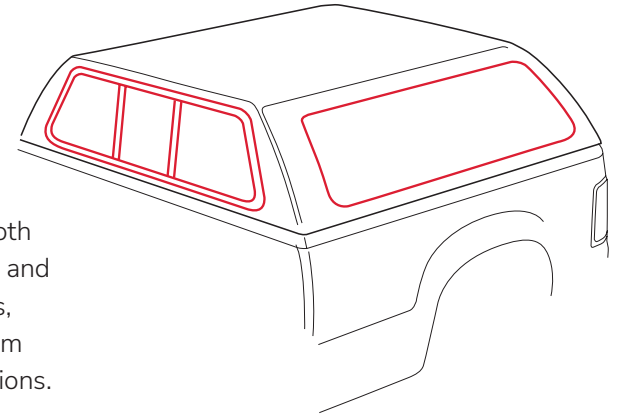

FRONT WINDOWS



Framed Front Picture Window



Removable Front Picture Window

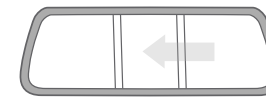

Framed Front Sliding Window

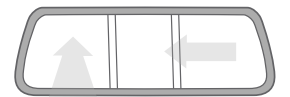

Removable Front Sliding Window*

SIDE WINDOWS

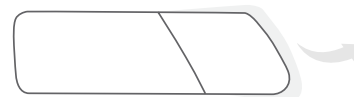

Side Windows w/Twist-Out Vents and Screens



One-Piece, Tip-Out Side Windows w/Screen (back part only)



Side Bay Windows



Radius Side Windows



Radius Side Window Sliders

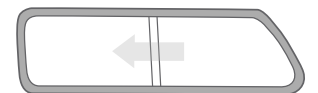

Sliding Windows w/Screens



100XQ SPORT

SPOIL YOURSELF

Our premium LEER fiberglass cap is loaded with features including an exclusive spoiler with integrated brake light. LEER 100XQ Sport is the cap that completes the factory look with incredible capability.

- One-Piece, Tip-Out Side Windows with Removable Screens
- Frameless, Compound Curved Glass Rear Door
- Specially Designed Water Management Channels
- Painted Door Skirt and Spoiler
- 20" Adjustable LED Tube Light
- Interior Headliner
- Keyless Entry

Limited availability. Consult your LEER Dealer for details.

100XQ

SLEEK & STYLISH

The head-turning LEER 100XQ features frameless, tip-out side windows designed to complement your truck's styling while providing optimal airflow. Its curved-glass rear door completes the look with premium hidden hinges and weather-resistant door skirt. In other words, if you want it all, 100XQ delivers.

- One-Piece, Tip-Out Side Windows with Removable Screens
- Frameless Curved Glass Rear Door
- Rotary Latch System
- Interior Headliner
- 20" Adjustable LED Tube Light
- + Keyless Entry

100XL

SUBSTANCE MEETS STYLE

Contemporary LEER 100XL has all of the right ingredients to make the most of your travel experience. Its fluid lines and premium components give the 100XL the look of a high-end SUV with the utility and capacity to win at any adventure.

- Frameless Side Windows with Twist-Out Vents and Screens
- Frameless Curved Glass Rear Door
- Rotary Latch System
- Interior Headliner
- 12V Dome Light
- + Keyless Entry

KEY • Standard + Option

STANDARD FEATURES ON ALL MODELS

- One-Piece Fiberglass Base Rails
- Limited Lifetime Warranty
- Recessed Third Brake Light
- Tinted Rear Glass Doors



100XR

A FAN FAVORITE

LEER enthusiasts appreciate the wide selection of available options to customize this cap to fit any lifestyle. And with its recessed side sliding windows with screens, the 100XR provides ventilation throughout the cap.

- Side Sliding Windows with Screens
- Frameless Curved Glass Rear Door
- Rotary Latch System
- 12V Dome Light
- + Keyless Entry with Upgraded Rear Door Lock and Side Drop T-Handles
- + Radius Side Windows
- + Radius Side Window Sliders
- + Aluminum Composite Side Access Doors with Double T-Handles
- + Solid Fiberglass Side Access Doors with Drop T-Handle Locks
- + Toolbox Options



100S

ESSENTIAL FEATURES, EXCEPTIONAL VALUE

This sleek, versatile truck cap is standard equipped with side sliding windows to catch the breeze. Option 100S with smooth sides for cargo privacy—it's the perfect place to add graphics to promote your business.

- Side Sliding Windows with Screens
- Double T-Handle Locks
- Framed Glass Rear Door
- Framed Front Picture Window
- 12V Dome Light
- + Smooth Sides†
- + Radius Side Windows†
- + Radius Side Window Sliders †
- + Keyless Entry (with Drop T-Handles)
- + Toolbox Options
- + Aluminum Composite Side Access Doors with Double T-Handle Locks
- + Solid Fiberglass Side Access Doors with Drop T-Handle Locks
- + Aluminum Composite Panel Rear Door with Double T-Handle Locks
- + Solid Fiberglass Panel Rear Door with Drop T-Handle Lock

† Non-recessed windows

- Framed Front Picture Window
- Designed for Custom Fit

- Axalta Automotive Paint
- Insulated Roof

- Gas Door Props
- Installation Bulb Seal

- J-Bolt Installation Clamps
- Skirted Rail (Varies by Model)



100R

FUNCTIONALITY MEETS SECURITY

Store, protect and organize gear with the LEER 100R. It's built with the standard features customers expect like large side sliding windows with screens. Perfect for traveling with pets[§], camping, or just adding some fresh air to your sports equipment, plants, or any cargo, LEER 100R helps make any haul an easy breeze.

- Side Sliding Windows with Screens
- Recessed Frame Rear Door
- Double T-Handle Locks
- 12V Dome Light
- + Radius Side Windows
- + Radius Side Window Sliders
- + Interior Headliner
- + Screen Protectors

[§] While vehicle is not in motion or running.

Limited availability. Consult your LEER Dealer for details.



180 MID-RISE

ELEVATED EXPERIENCE

Take capability to new heights with the LEER® 180. This mid-rise cap features double T-handle locks for security with a twist of the wrist and side sliding windows with screens to help keep things cool.

- Up to 15% more Interior Room over Cab-High Models
- Recessed Framed Rear Door with Double T-Handle Locks
- Recessed 50/50 Sliding Side Windows with Screens
- 12V Dome Light
- + Interior Headliner
- + Radius Side Windows
- + Radius Side Window Sliders

Limited availability. Consult your LEER Dealer for details.

KEY • Standard + Option

STANDARD FEATURES ON ALL MODELS

- One-Piece Fiberglass Base Rails
- Recessed Third Brake Light
- Limited Lifetime Warranty
- Tinted Rear Glass Doors



122 HIGH-RISE

REACH NEW HEIGHTS

The spacious high-rise LEER 122 is crafted for the most demanding jobs, providing up to 40% more interior room over cab-high models. Plus, the taller door opening makes loading large items a breeze.

- Aerodynamic High-Rise Profile
- Side Sliding Windows with Screens
- Framed Side Bay Window
- Recessed Framed Rear Door with Double T-Handle Locks
- 12V Dome Light
- + Full Length Sliders†
- + Radius Side Windows†
- + Radius Side Window Sliders†

Limited availability. Consult your LEER Dealer for details.

- Framed Front Picture Window
- Axalta Automotive Paint
- Designed for Custom Fit
- Insulated Roof



180XL FORD FEATURED PRODUCT

Add more mojo to your Maverick. The LEER 180XL is custom designed to complement the distinctive body lines of the Maverick truck. 180XL's mid-rise height adds 15% extra capacity to this compact truck bed. One-piece twist-out side windows add extra flair to the unique styling.

- Integrated Rear Spoiler
- Framed Front Picture Window
- One-piece Twist-out Side Windows with Screens
- Curved Glass Rear Door with Bonded Hinge
- ABS Door Skirt – Textured Black
- 12V Dome Light
- 12V Fuse Box
- Standard J-Bolt Clamp System
- Unique Bedrail Seal
- + Interior Headliner
- + Removable Front Picture Window
- + Removable Front Sliding Window
- + Clothes Hanger - Single or Double
- + Cargo Hooks - 4 or 8
- + Dual 12V Dome Light
- + Battery Dome Light
- + Dual Battery Dome Light
- + 20" Tube Light - Rear (Option A)
- + 12V 3-Outlet Power Block
- + Wiring Harness - Typical 3 Wire

- Gas Door Props
- Installation Bulb Seal
- J-Bolt Installation Clamps
- Skirted Rail (Varies by Model)

Every LEER cap comes loaded with standard features to help you work hard and play easy. Additional accessories are also available to customize your cap for added utility, ventilation, security, and convenience. Find what's right for you.



KEYLESS ENTRY (USING YOUR TRUCK'S KEY FOB)



SCREEN PROTECTORS



INTERIOR CLOTHES HANGER (SINGLE OR DOUBLE)

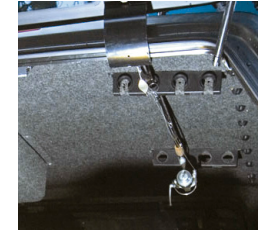

FISHING ROD HOLDER

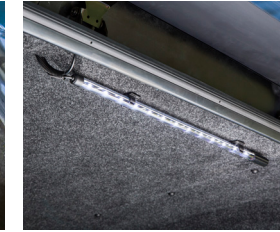

LED TUBE LIGHTING

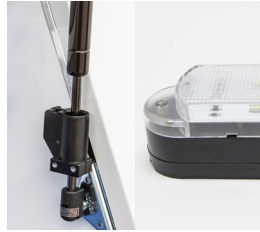

SWITCH ACTIVATED LIGHTING



INTERIOR HEADLINER



THREE-OUTLET 12-VOLT POWER BLOCK



OVERHEAD GEAR NET (REQUIRES ROOF RACK)



INTERIOR ROOF-MOUNT CARGO HOOKS

UP-GRADES.

TOOLBOX OPTIONS

Take your LEER cap to work with these popular toolbox options: available on 100S and 100XR (requires side access doors).

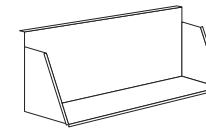

OPTION A

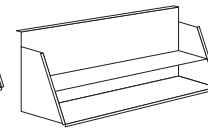

OPTION B

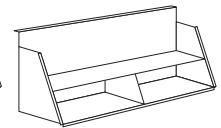

OPTION C



Top off your LEER truck cap with a wide assortment of Thule roof racks and track systems. It's the finishing touch that helps you pile on the possibilities.



THULE TRACKS ONLY
(Works with most track mounted crossbars)



THULE SQUARE LOAD BAR
Roof Rack System

- Steel | 47", 53", 60" | Black
- Price conscious customers will like the basic function. 7" slot for mounting feet.



THULE WING BAR
Evo Roof Rack System

- Aluminum | 47", 53" | Black or silver
- Aluminum crossbar won't rust. Wing shape provides a quieter ride. 7" slot for mounting feet.



THULE PRO BAR
Roof Rack System

- Aluminum | 69", 78" | Black
- Works well with wider trucks but features a mounting slot along the entire length of the crossbar making this style more flexible.



RECREATIONAL TRUCK CAP COMPARISON CHART

- 1 Requires Headliner
- 2 Requires Fuse Box
- 3 Requires Full Cap Headliner
- 4 Not Available with LEER Locker
- 5 Not Available with Toolbox
- 6 Not Available with 2022-2025 Ford Maverick
- 7 Requires Thule Tracks or (8) Cargo Hooks for Install
- 8 100S TC24, FR24, FR25-R, TT22 Specialty Clamps included as Standard

Not all options are available for all models and trucks. LEER maintains the right to add, delete, or change designs and/or suppliers of options when necessary to maintain or improve the overall quality without written notice.



LEER LOCKER™

Organization is key. LEER Locker transforms overhead space into a sliding drawer to make order out of any chaos. Tools, sports equipment, landscaping — you name it.

LEER Locker is the pro's tried, true, and tested storage solution forged to handle the toughest wear, and the most random of requests.

** Not available on 2022-2025 Ford Maverick*

BEDSLIDE®

Your world is now at your fingertips with BEDSLIDE®. This innovative slide system puts everything easily within reach. And with a selection of models with capacities ranging from 1,000 to 2,000 lbs. and options that include multiple bins to organize tools and recreation gear, BEDSLIDE is a proven winner.



	• Standard	+ Option		100XQ SPORT	100XQ	100XL	100XR	100R	100S	180 MID-RISE	122 HIGH-RISE
FRONT WINDOW	Framed Front Picture Window	•	•	•	•	•	•	•	•	•	•
	Framed Front Sliding Window	+	+	+	+	+	+	+	+	+	+
	Removable Front Picture Window	+	+	+	+	+	+	+	+	+	+
	Removable Front Sliding Window	+	+	+	+	+	+	+	+	+	+
	Solid Front - No Front Window	+	+	+	+	+	+	+	+	+	+
SIDE	One-piece Tip-Out Side Window	•	•								
	Side Sliding Windows				•	•	•	•	•	•	•
	Frameless Side Windows w/Twist-Out Vents			•							
	Radius Side Window				+	+	+	+	+	+	+
	Radius Side Window Slider				+	+	+	+	+	+	+
	Aluminum Composite Side Access Door w/2 T-Handles				+				+		
	Solid Fiberglass Side Access Door w/Drop T-Handle				+				+		
	Solid Side - No Window				+	+	+	+	+	+	+
	Screen Protector (Available for Side Sliding Window)				+	+	+	+	+	+	+
	Keyless Entry Side Door (Available on 100S w/Drop T-Handle only)				+				+		
REAR DOOR	Recessed Framed Rear Door w/2 T-Handle Locks							•	•	•	•
	Frameless Hidden Hinge Curved Rear Door	•	•	•	•						
	Framed Aluminum Composite Panel Rear Door w/2 T-Handles								+		
	Framed Solid Fiberglass Panel Rear Door w/Drop T-Handle								+		
	LEER Twist Handle Lock w/Flip-Up Weather Cover	•	•	•							
	LEER Flip-Lock Handle				•						
	Automotive Style Rotary Latches	•	•	•	•						
	Keyless Entry Rear Door (Available on 100S w/ Drop T-Handle only)	•	+	+	+				+		
	12V Dome Light			+	•	•	•	•	•	•	•
	Dual 12V Dome Light			+1	+1	+1	+1	+1	+1	+1	+1
LIGHTS/ELECTRIC	20" Adjustable LED Tube Light - Rear Location	•	•	+					+		
	20" Adjustable LED Tube Light - Additional Locations						+1		+1		
	Dual 20" Adjustable LED Tube Light	+1	+1	+1	+1				+1		
	Dual 42" Adjustable LED Tube Light	+1									
	Gas Prop Switch for 12V Dome or LED Tube Light	+	+	+	+	+	+	+	+2	+2	+2
	Battery Dome Light			+	+	+	+	+	+	+	+
	Dual Battery Dome Light			+	+	+	+	+	+	+	+
	No Interior Light	+	+	+	+	+	+	+	+	+	+
	12V 3-Outlet Power Box	+	+	+	+	+	+	+	+	+	+
	7-Way Harness	+	+	+	+	+	+	+	+	+	+
INTERIOR	Fuse Box	•	•	•	•	•	•	•	•	•	•
	Headliner	•	•	•	+	+	+	+	+	+	+
	Toolbox - Option A, B, or C								+		
	Non-Slip Mat for Toolbox Shelf								+		
	Headliner - Exterior of Toolbox						+3		+3		
	Clothes Hanger - Single and Double Options	+4	+4.6	+4	+4	+4	+4	+4	+4	+4	+4
	Fishing Rod Rack - Single and Double Options	+4	+4	+4	+4	+4	+4	+4	+4	+4	+4
	LEER Locker	+7	+7	+6	+5.6	+5.6	+5.6	+5.6	+5.6	+5.6	+5.6
	Gear Net	+4.7	+4.7	+4.7	+4.7	+4.7	+4.7	+4.7	+4.7	+4.7	+4.7
	Cargo Hooks - 4 and 8 Hook Options	+4	+4	+4	+4	+4	+4	+4	+4	+4	+4
RACKS	Thule Tracks Only	+	+	+	+	+	+	+	+	+	+
	Thule w/Square Load Bars (50" or 60")	+	+	+	+	+	+	+	+	+	+
	Thule w/WingBar Evo Silver or Black (47" or 53")	+	+	+	+	+	+	+	+	+	+
	Thule w/Pro Bars (69" or 78")	+	+	+	+	+	+	+	+	+	+
	Thule Roof Rack Accessories	+	+	+	+	+	+	+	+	+	+
	Kargo Master and Prime Design Commercial Racks								+		
Installation Components - Bulb Seal, J-Bolt Clamp System	•	•	•	•	•	•	•	•	•	•	

LOAD UP

WITH

THE

LEADER

Complete your Ford Truck with North America's Most Trusted Truck Cap Brand

VISIT LEER.COM



MAVERICK

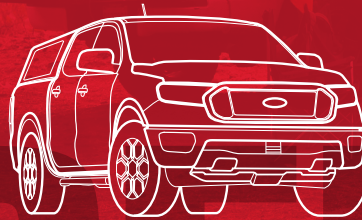

RANGER



F-150

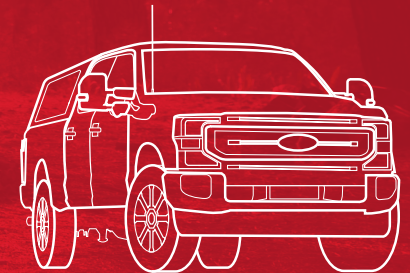

SUPER DUTY

All illustrations and specifications contained in this literature are based on the latest product information at the time of publication. Check with your local LEER Retailer for complete product information. LEER reserves the right to make changes in prices, colors, materials, equipment, specifications, and models at any time without notice or prior obligation.

© 2026 Truck Accessories Group, LLC d/b/a Leer Group; a J.B. Poindexter Company. #LG-339

Backed by the LEER Limited Lifetime Warranty. See complete warranty statement for details.

⚠ CALIFORNIA PROPOSITION 65 WARNING

WARNING: This product contains chemicals known to the State of California to cause cancer and birth defects or other reproductive harm.

For more information:
P65Warnings.ca.gov

AUTHORIZED LEER RETAILER

REV 01/26

